

533490

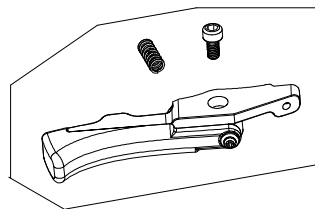

533492

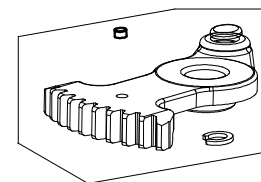

533493

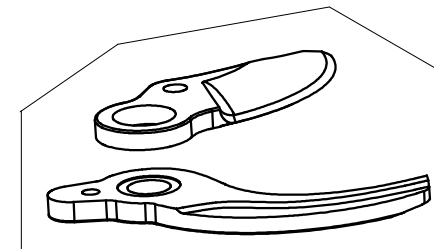

533494

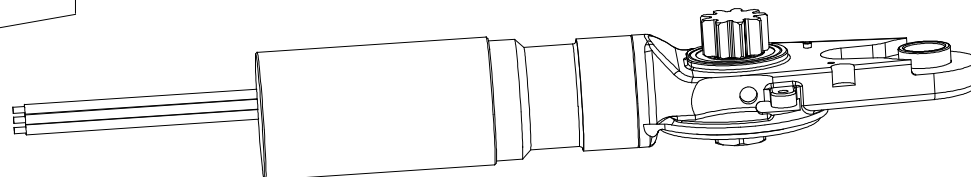

533491

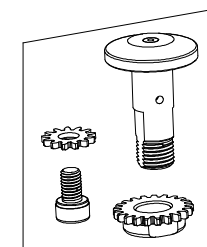

533495

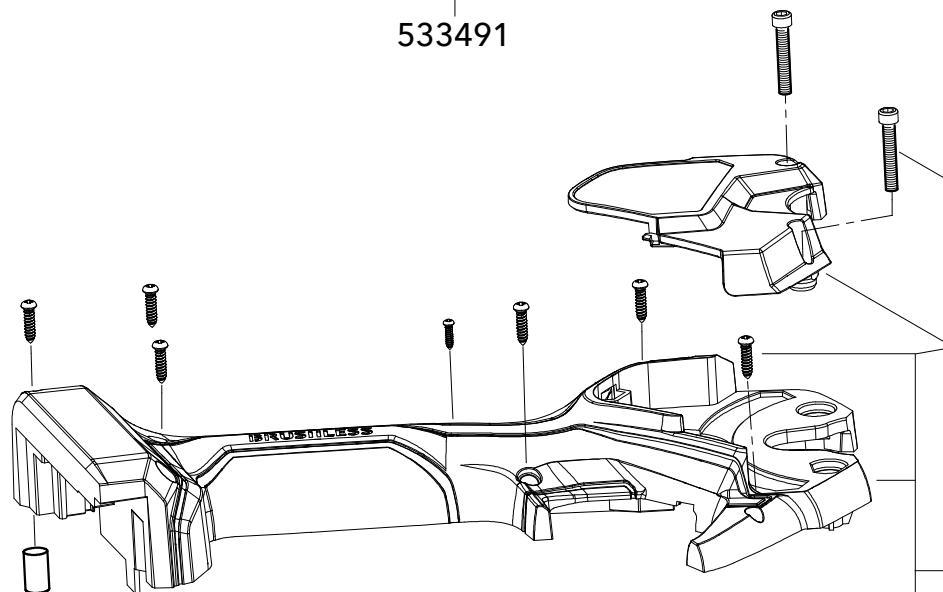

533489

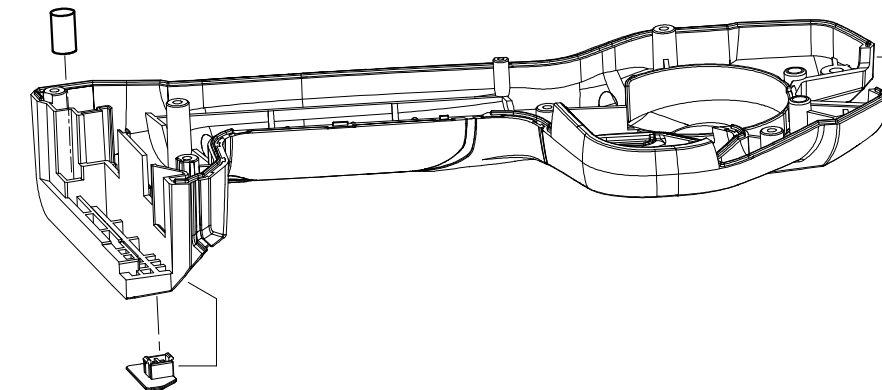

GPS 35 18-EC

Zeichng.-Nr. 533699 Datum 07-2024
Drawing-no. 533699 date 07-2024